

**DIMENSIONS IN INCHES**

\*\*\* DIMENSIONS ARE APPROXIMATE \*\*\*

DRAWN JLT	3/23/2016	Blue Falls Manufacturing Ltd.		
CHECKED		TITLE		
QA		SUMMIT XL SHELL_CABINET_FLOOR DIMENSIONS (in)		
MFG		SIZE	DWG NO	REV
APPROVED		A4		
		SCALE		SHEET 1 OF 4

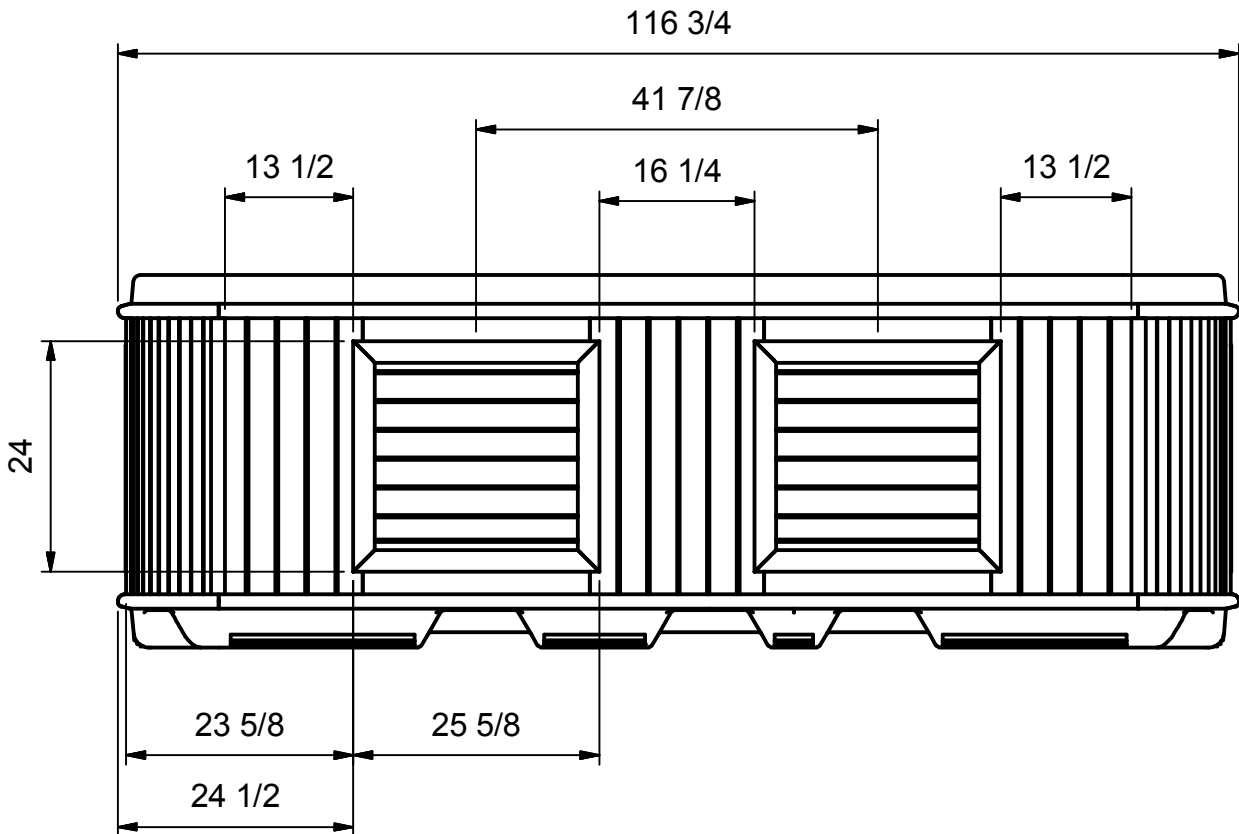

**DIMENSIONS IN INCHES**

\*\*\* DIMENSIONS ARE APPROXIMATE \*\*\*

DRAWN JLT	3/23/2016	Blue Falls Manufacturing Ltd.		
CHECKED		TITLE		
QA		SUMMIT XL SHELL_CABINET_FLOOR DIMENSIONS (in)		
MFG		SIZE	DWG NO	REV
APPROVED		A4		
		SCALE		SHEET 2 OF 4

# SUMMIT XL FLOOR LONG SIDE

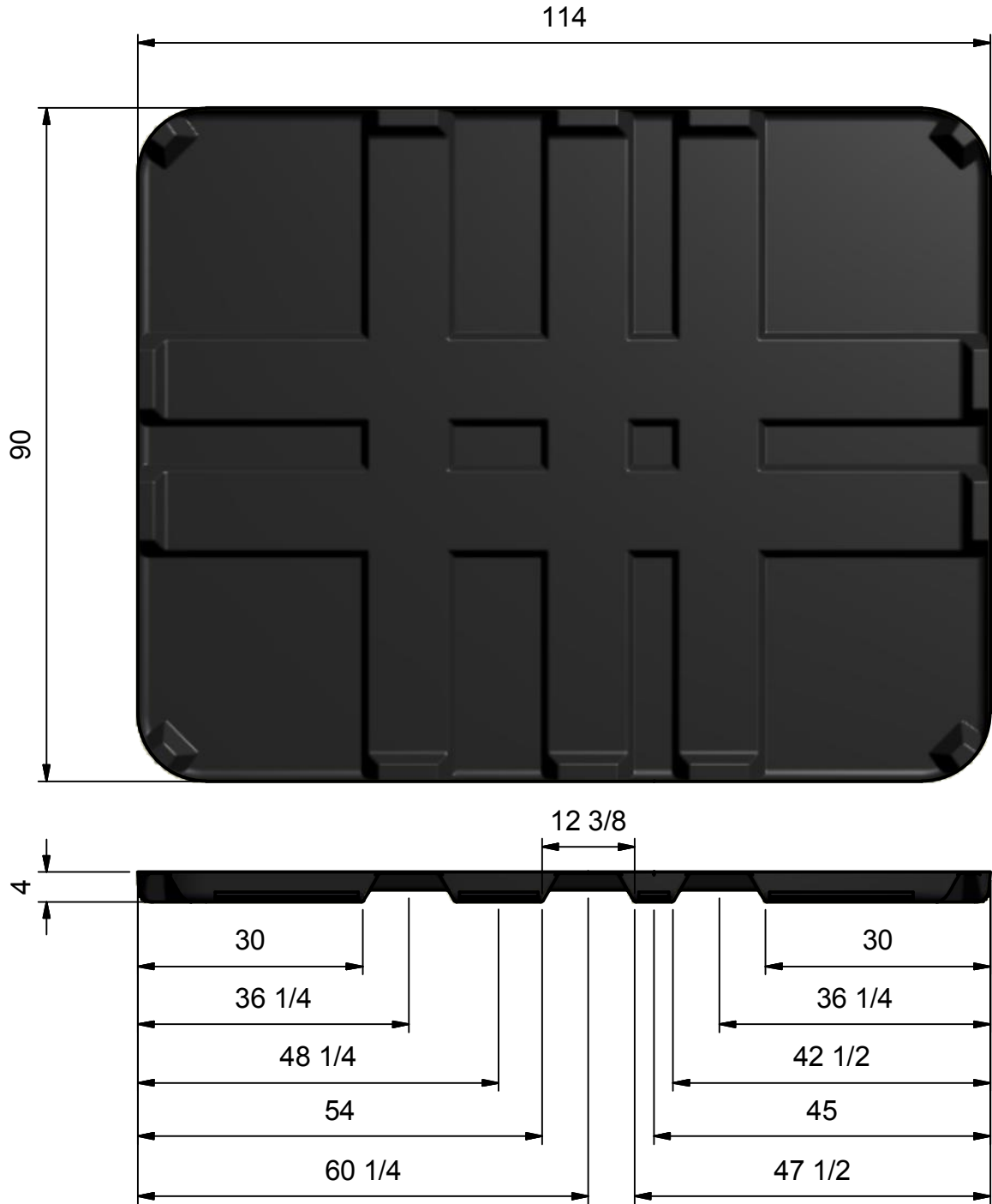

## DIMENSIONS IN INCHES

\*\*\* DIMENSIONS ARE APPROXIMATE \*\*\*

DRAWN JLT	3/23/2016	Blue Falls Manufacturing Ltd.		
CHECKED				
QA		TITLE		
MFG		SUMMIT XL SHELL_CABINET_FLOOR DIMENSIONS (in)		
APPROVED		SIZE	DWG NO	REV
		A4		
		SCALE	SHEET 3 OF 4	

# SUMMIT XL FLOOR SHORT SIDE

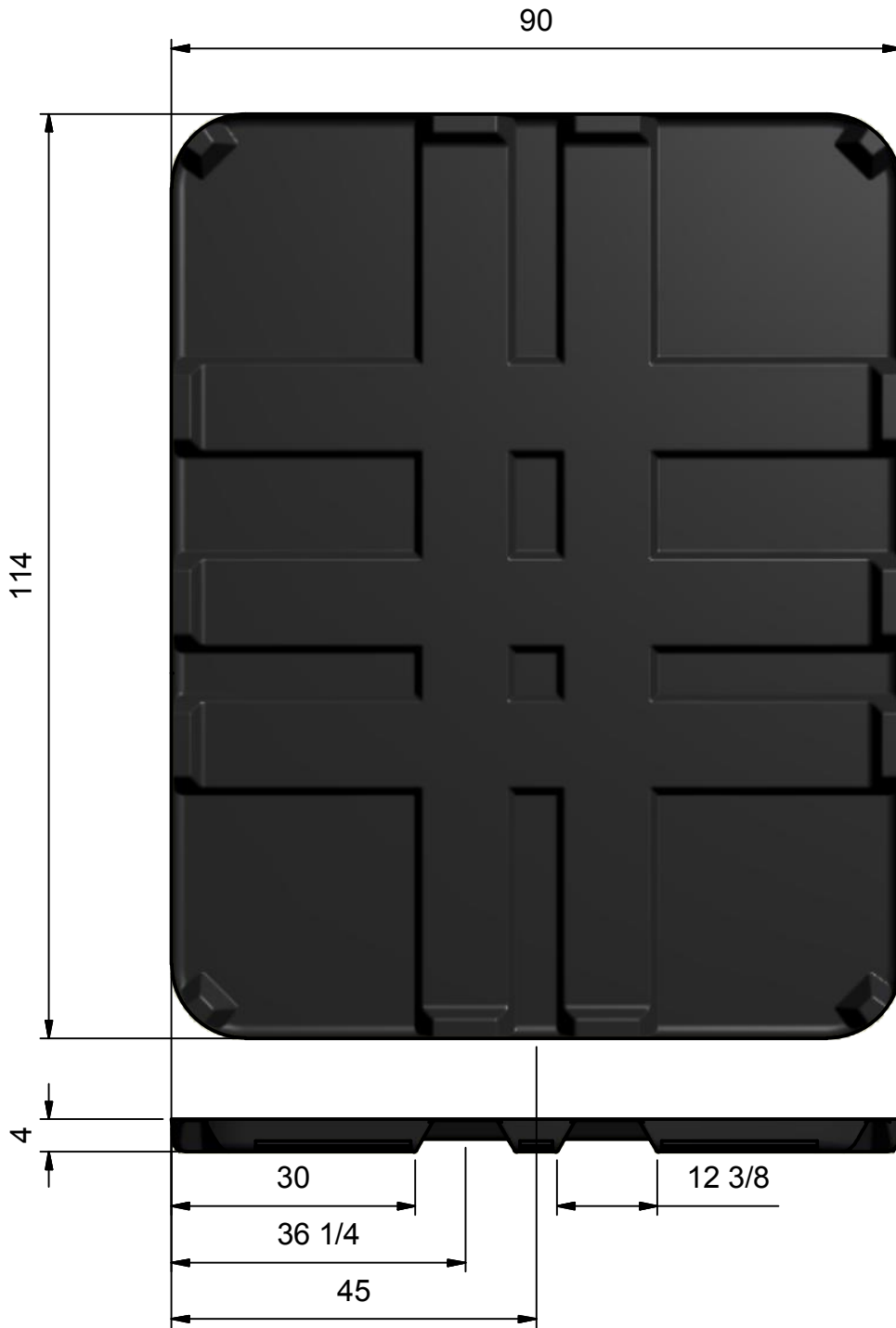

## DIMENSIONS IN INCHES

\*\*\* DIMENSIONS ARE APPROXIMATE \*\*\*

DRAWN JLT	3/23/2016	Blue Falls Manufacturing Ltd.		
CHECKED		TITLE		
QA		SUMMIT XL SHELL_CABINET_FLOOR DIMENSIONS (in)		
MFG		SIZE	DWG NO	REV
APPROVED		A4		
		SCALE		SHEET 4 OF 4